

ONMSi: Optical Network Monitoring System



Fiber Network Visibility that Scales for Both PON and Point-to-Point Networks

- Drastically reduce network downtime
- Improve network reliability and SLA management
- Reduce fiber optic maintenance costs
- Expand visibility out to your customers (PON)
- Protect network integrity

The ONMSi Remote Fiber Test System

Key Benefits

- Saves OpEx, reducing mean-time-to-repair and network downtime by at least 30%
- Anticipates service disruptions before service is affected
- Simplifies SLA management
- Protects fiber assets with long-term performance monitoring
- Improves troubleshooting and demarcation between providers
- Detects fiber tapping, protecting valuable information from intrusion

Key Features

- Supports P2P (metro/core/access) and P2MP (PON) to the optical network terminal (ONT)
- Compact and reliable optical test unit (OTU) design
- Domain architecture enables maximum organizational flexibility
- Integrates geographical maps of the fiber network with OTDR trace cursor tracking
- Secures multiuser environments compatible with LDAP
- Supports web services (XML) and SNMP for easy integration with open-source software (OSS) and geographical information systems (GIS)
- High-availability solution with automatic failover between two servers
- Multiple dashboards showing current performance and diagnostics data

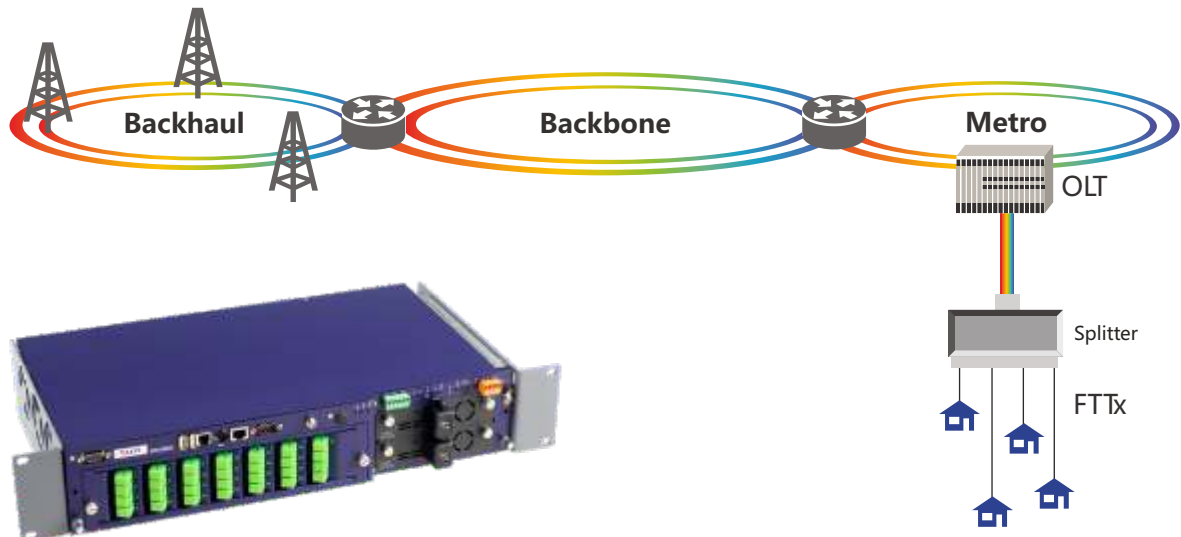

ONMSi offers a comprehensive fiber monitoring solution: it supports metro, core, access, and PON networks

The explosion of voice, video, and data anywhere and anytime means that network service providers need constant availability and performance from their fiber optic network. The ability to provide quad/triple play and passive optical network (PON) architectures with optical splitters has made fiber monitoring an even bigger challenge.

The Viavi Solutions™ ONMSi is an optical network monitoring system that expands network visibility right from the core across the PON and into the premises—improving operational support and quality-of-service (QoS) for any type of network.

ONMSi is a remote fiber test system that scans the fiber network 24/7 and automatically detects and locates faults without having to dispatch technicians in the field. Based on industry-leading Viavi optical technologies, an OTU integrating an optical time domain reflectometer (OTDR) and an optical switch constantly compares data to a baseline and sends alarms if any fiber degradation occurs.

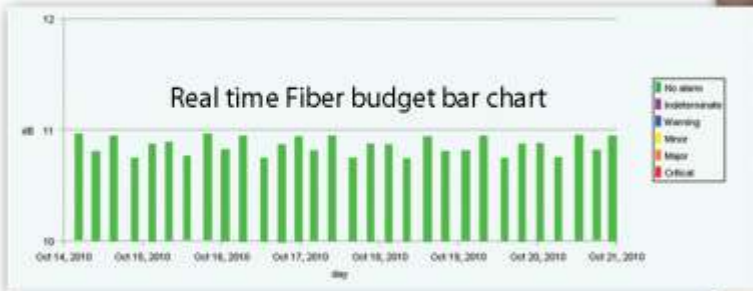

Allocated time per monitored fiber

Label	Port	Test	Severity	Event date	Last date	Next estimated date	Allocated Time (%)
201201010101	OS/1	Allocating/OTDR		2012 Jan 31 11 01 24	2012 Jan 31 11 02 34		43.43
201201010101	OS/1	Allocating/OTDR		2012 Jan 31 11 02 48	2012 Jan 31 11 01 58		53.08



FLEXIBLE TO MEET YOUR NEEDS

Scalable for PON

Using the same software and hardware, ONMSi is perfectly adapted for P2P or P2MP networks. The system can be easily configured by the user for a long-distance metro/core test or for a short-distance PON, extending the fiber visibility of the network operations center (NOC) up to the FTTH subscriber.

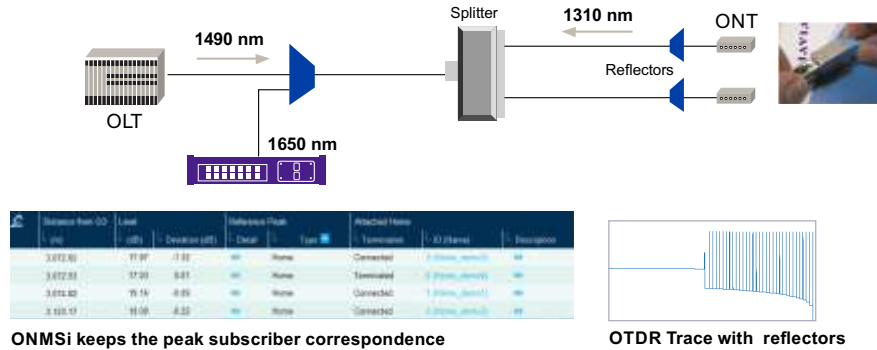

ONMSi Fits your Application Needs

Whatever fiber monitoring application (for example, fast fault location, accurate location of small fiber changes, quick set up) you are targeting, ONMSi fits your needs. For example, fiber-test setup can be done with one click by a non-OTDR-expert for a standard configuration, or a fiber optic master can address advanced applications with the multiple possibilities offered by ONMSi for test configurations.

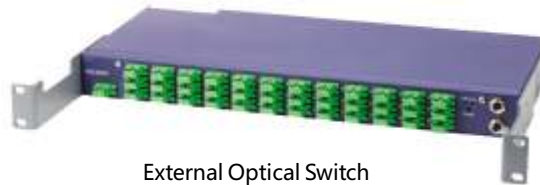

The OTU-8000 — Compact, Reliable, and Versatile

The ONMSi OTU-8000 is a compact, 2U-high, rack-mounted unit housing both the OTDR and optical switch modules. A single OTU-8000 can house up to two OTDRs and up to 48 optical switch ports. Capacities of more than 1000 switching ports are achieved by adding multiple external switch units (1U high, 36 ports each). Intelligently managing power distribution between optical switches typically consumes 35 W independently from the number of external switches.

Installed in unmanned sites, the OTU-8000 uses dual power supply feeds and solid-state memory (no magnetic hard disk) for unprecedented reliability. It ensures that alarms will notify operators if the primary communication channel fails and will switch automatically to a backup channel. If communication cannot be established with the ONMSi server, the OTU-8000 will notify users by e-mail or SMS.

With its multiple test capabilities, the OTU-8000 can accurately locate a fault within a span of 200 km or test 32 fibers in less than 1 minute. This versatility lets it fit applications where slow fiber degradation is researched. And, it quickly detects intrusion that threatens network integrity.



Flexible Domain Architecture

To address different organizations, the ONMSi data model is based on domains. The user can create a collection of ONMSi objects such as OTU, P2P network, PON, fiber link, fiber section and subdomains. The same object can belong to more than one domain. User permissions can be created per domain. For example, a top-down regional organization may use regional domains whereas a dark-fiber provider may use customer or link domains. Large field-service maintenance teams can create privileges so that users can access all the OTUs existing in a network.

Easy Integration with Legacy Systems

With complex IT environments, integrating a test system is often a key success factor for a project. ONMSi can be provided with two different interfaces: SNMP and web services (XML over HTTP). This flexibility ensures integration with OSS, GIS, and other IT back-office systems.

ONMSi alarm management is also compliant with OSS-J initiatives and ITU-X733

Scalable System from One up to Hundreds of OTUs

ONMSi can scale easily and help lower total cost of ownership. Starting with one OTU-8000, the system can scale as the network expands. ONMSi systems with more than one hundred OTUs can monitor very large national and international backbone networks.

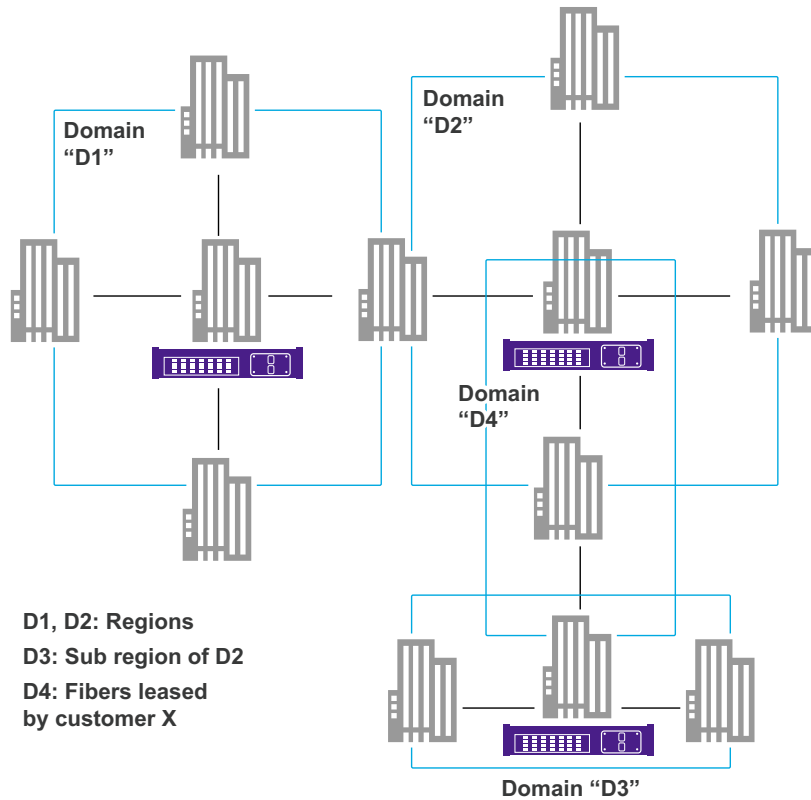

D1, D2: Regions
 D3: Sub region of D2
 D4: Fibers leased by customer X

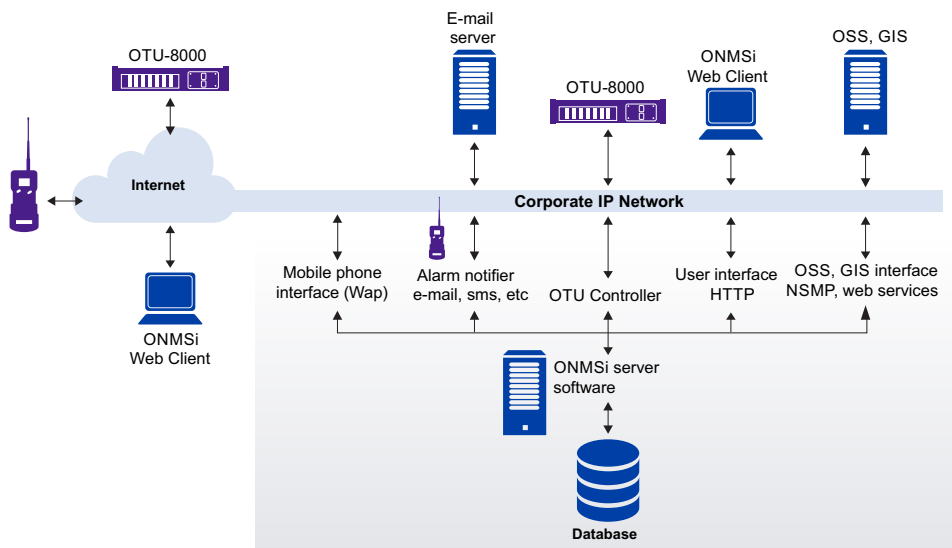

FEATURES

Secured Multi-User Environments Compatible with LDAP

Lightweight directory access protocol (LDAP) simplifies directory management by providing users and applications in an enterprise with a single, well-defined, standard interface to a single, extensible directory service. ONMSi integration with LDAP avoids time-consuming data entry and ensures that the current security policy is respected.

Instant View of System Health and Fiber Performance

Lightweight directory access protocol (LDAP) simplifies directory management by providing users and applications in an enterprise with a single, well-defined, standard interface to a single, extensible directory service. ONMSi integration with LDAP avoids time-consuming data entry and ensures that the current security policy is respected.



Allocated time per monitored fiber

Link	Port	Test	Severity	Execution	Last date	Next estimated date	Allocated Time (%)
Aggr1000	OS/1	Measurement/OTDR			2012 Jan 11 11:01:24	2012 Jan 21 11:02:34	40.43
Port1000/OTDR	OS/0	Measurement			2012 Jan 11 11:00:40	2012 Jan 21 11:01:00	83.09



ONMSi geographical map

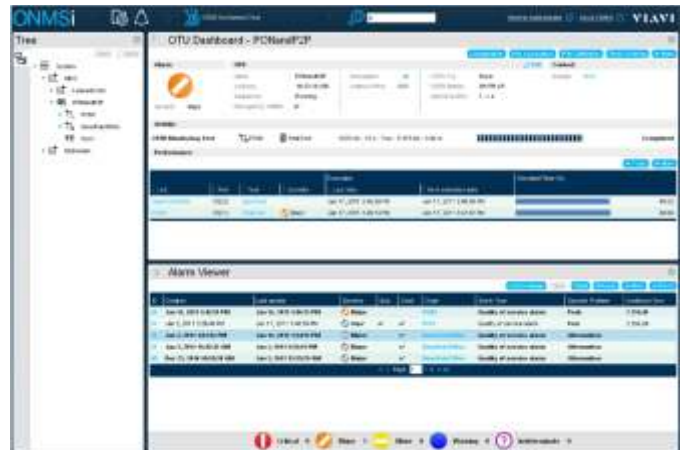

ONMSi alarm management

High Availability with Automatic Failover

ONMSi can be provided with two servers for almost 100% availability. The database is duplicated between the two servers but only one server is active at any one time. The server in standby mode constantly monitors the active server, and if a no-response situation occurs, it will switch to become the active server and run ONMSi.

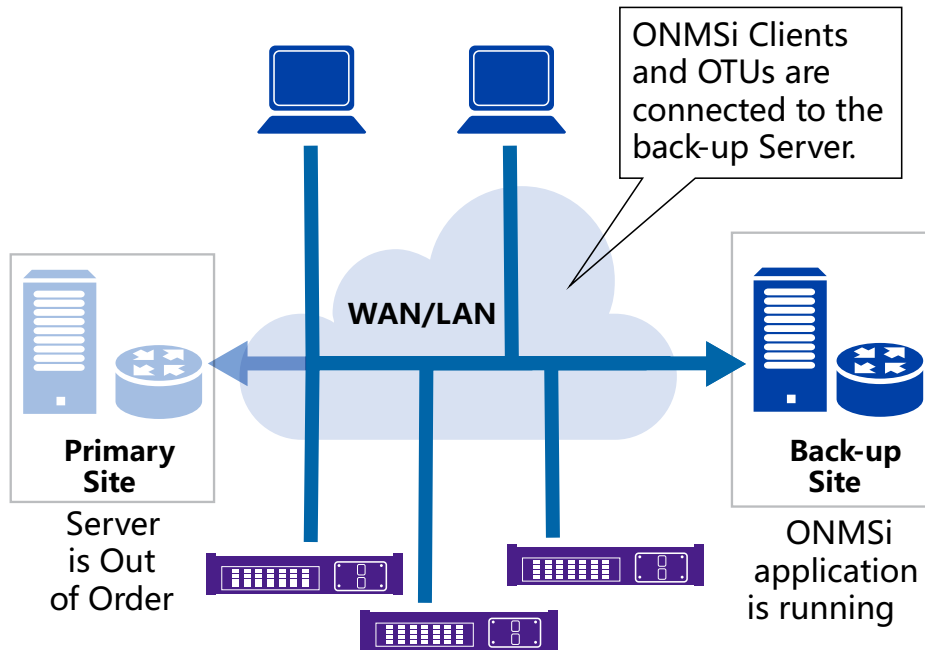

Detailed Fault Localization

When a fiber fault is detected, ONMSi provides the OTDR distance and useful information such as distances from the nearest landmarks. With this information, the dispatch team knows immediately where they need to go, saving valuable time.

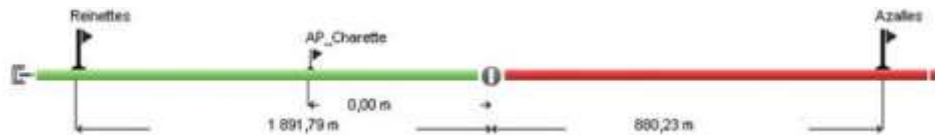

Integrated Geographical Map

The ONMSi user interface displays both alarm data and fault locations simultaneously, avoiding the need to switch applications. The embedded map provides all the relevant alarm data including fiber-fault location and cable routing.

Comprehensive Alarm Management

ONMSi integrates a powerful alarm management module compliant with OSS-J initiatives and ITU-X733. This ensures easy integration with an OSS or a trouble-ticket system. The learning phase of users at the NOC is reduced by using the same alarm mechanisms that they use in other network management systems.

In addition, ONMSi can notify remote users by SMS or e-mail when an alarm occurs. These notifications can be filtered by a calendar integrated with a user's preferred agenda.



ONMSi geographical map

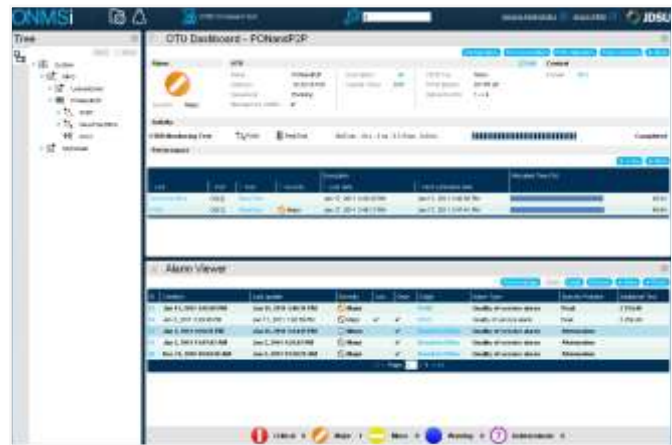

ONMSi alarm management

THE PLUS SERVICES PORTFOLIO



Consulting Application Engineering

Viavi works closely with customers from the start to identify needs and recommend the best system to meet business requirements. Working together, we carefully evaluate all the relevant details such as network topology, dark or active fiber, growth projections, and communication protocols.

An Experienced Team for Installing, Deploying, and Commissioning

A Viavi project manager manages each project through to acceptance with the help of a team of experienced Viavi engineers, product managers, and system specialists.

Staff User-Adoption Training

A wide range of training options are available to ensure that engineering staff and field-maintenance teams are able to maximize the advantages of the ONMSi, increasing staff efficiency

Support Services

Customized gold, silver, and bronze support contracts complement the power of the ONMSi with the following benefits:

- Minimizes system downtime through proactive system check-ups and guaranteed turn-around times.
- Improves system functionality and keeps systems current with scheduled software enhancements.
- Protects investments with continuous system maintenance and updates.
- Avoids unexpected expenses with on-site calibrations , express-loaner options, and optional on-site repair.

Based on More than 20 Years of Remote Fiber Test System (RFTS) Experience

Viavi is proud to have the world's largest installed base of clients using an RFTS to guarantee their network performance 24/7. By keeping compatibility between different generations of software and hardware as much as possible, we have speeded return-on-investment and extended system lifetimes.



📍 203, Ansal Chamber-II, 6, Bhikaji Cama Place, New Delhi-110066
☎ +91 11 26700500/26103358 📠 +91 11 26183229 📠 +91-9212605204
✉ marketing@savitritelecom.com

@2021 Savitri Telecom Services
Product specifications and descriptions in this document are subject to change without notice.
@0921STSACds-ONMSI-001